

Triflag

INSTALL guide

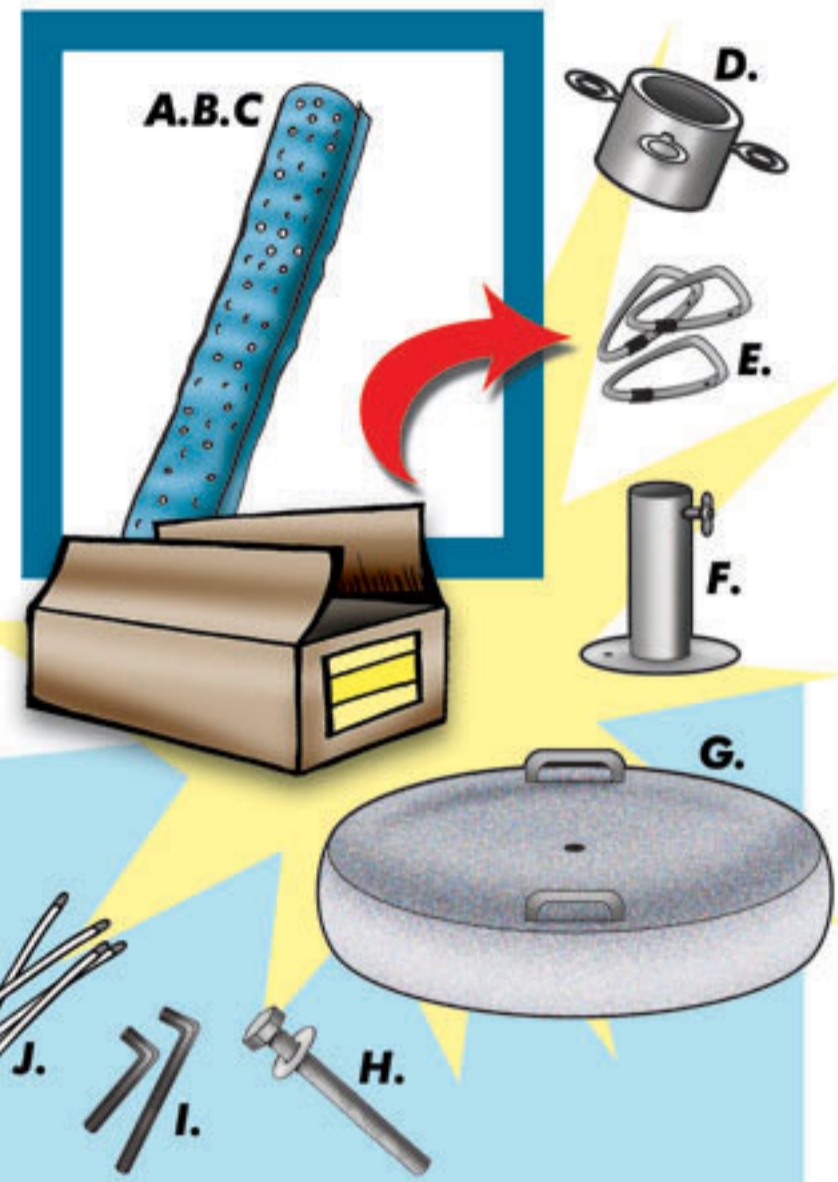

1.



2.

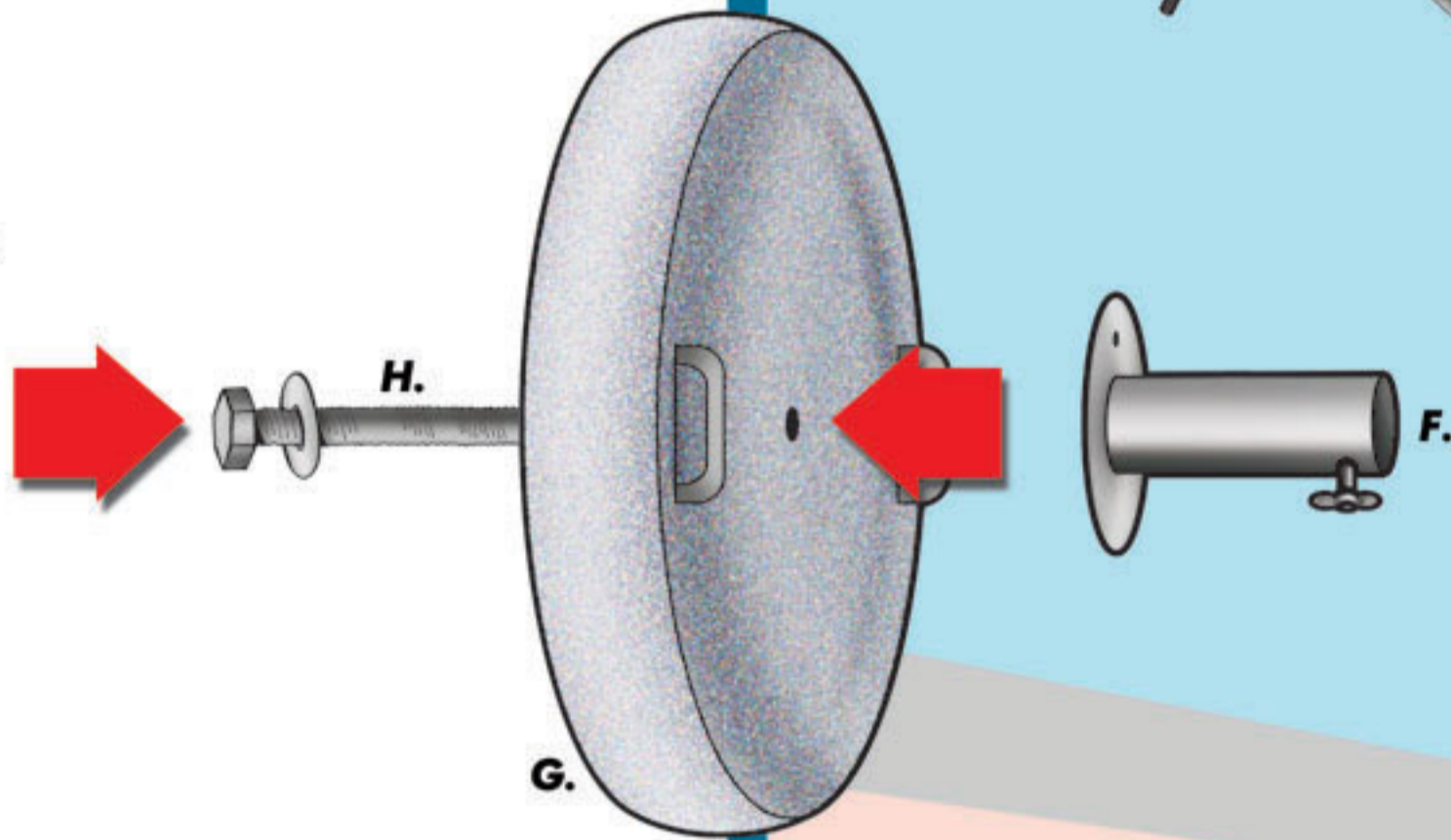

3.

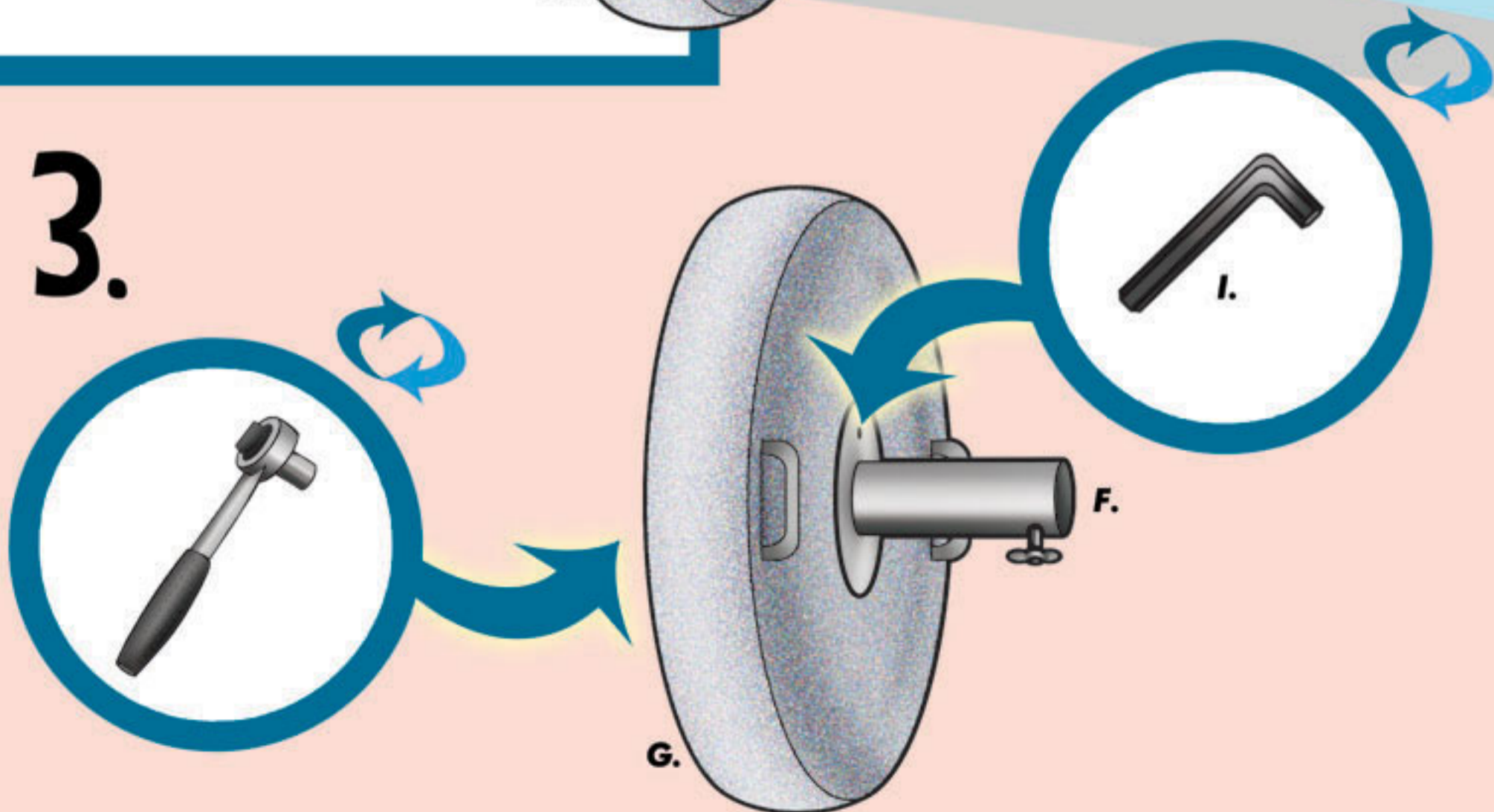

4.

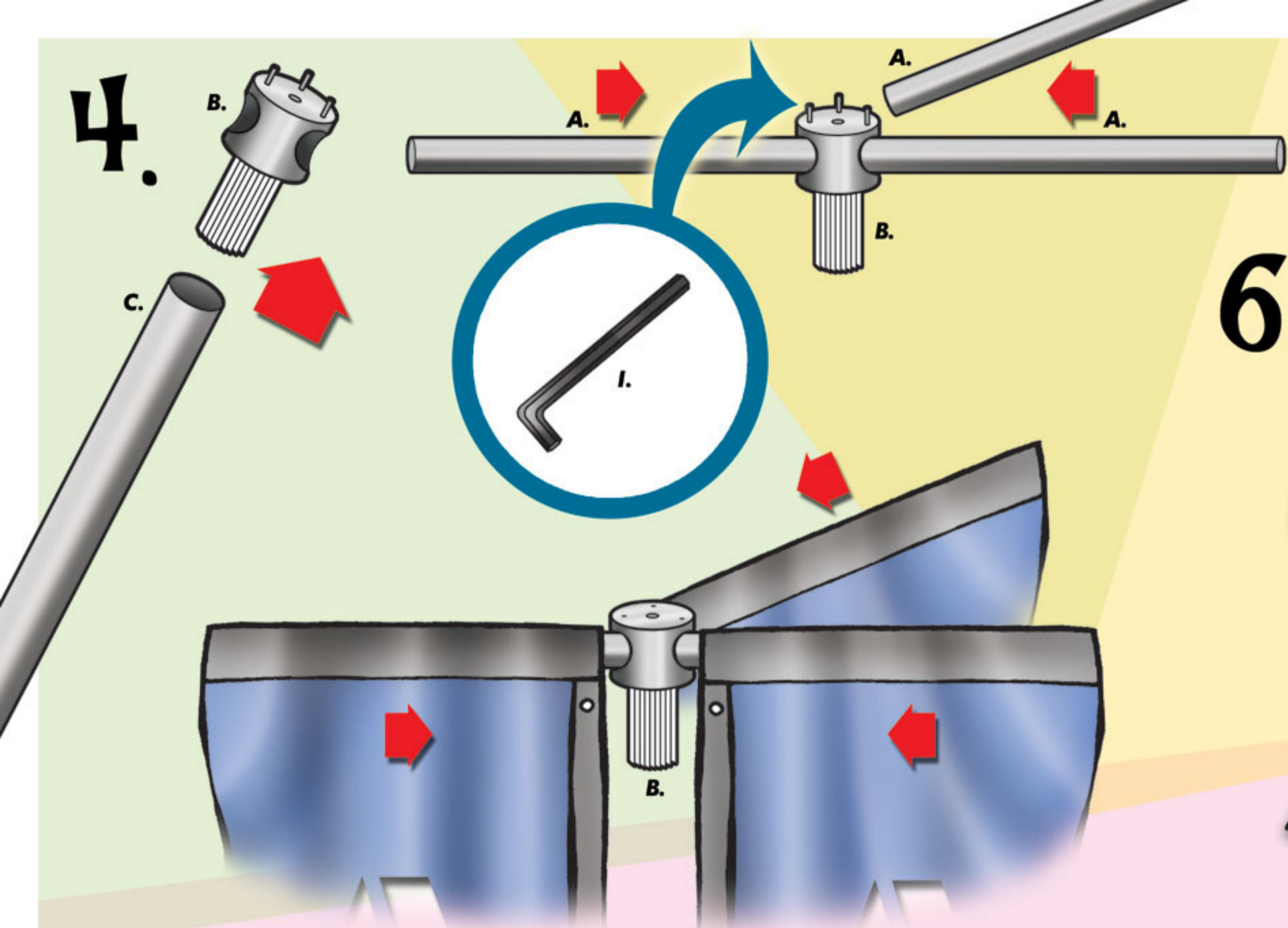

6.

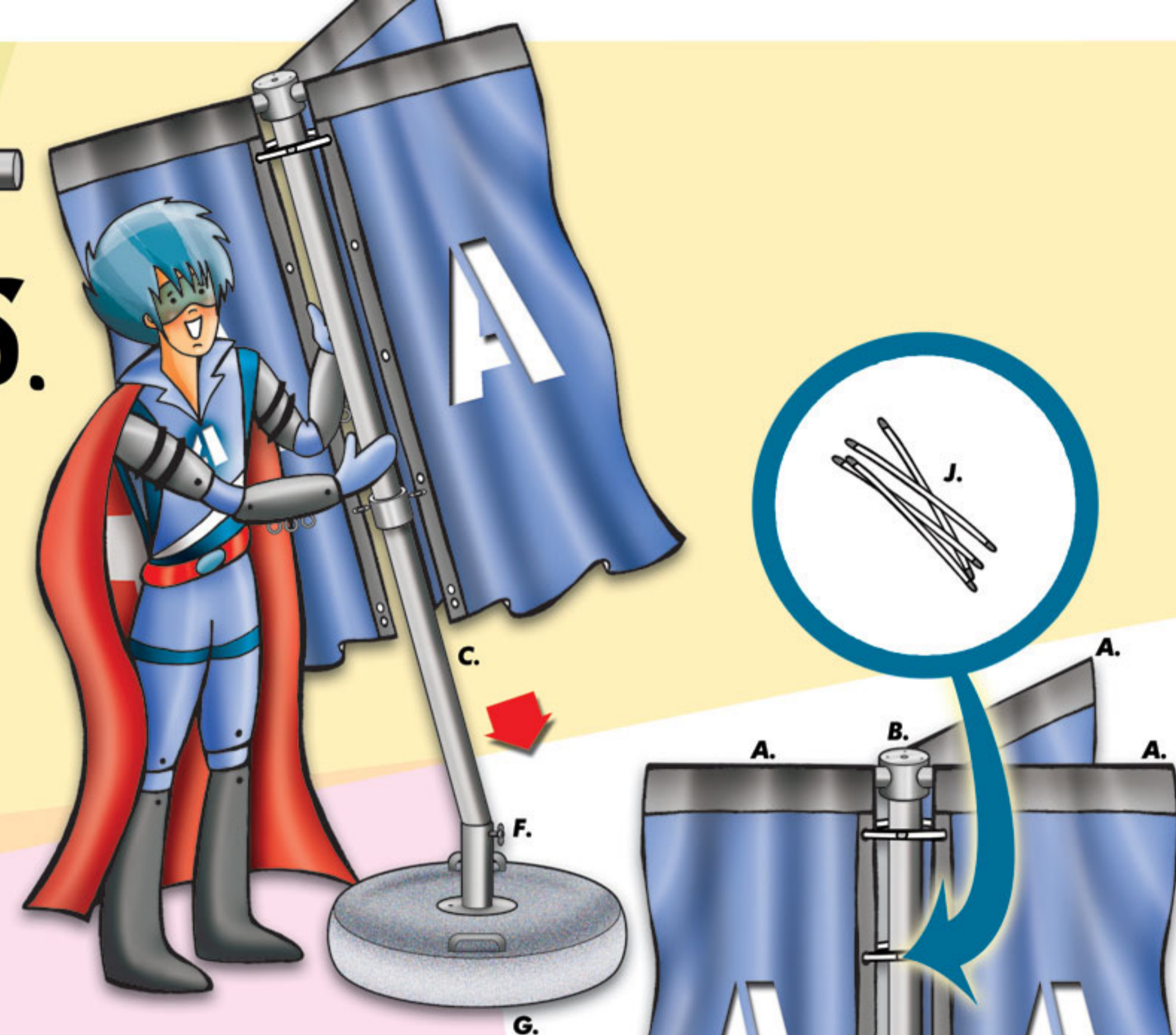

5.

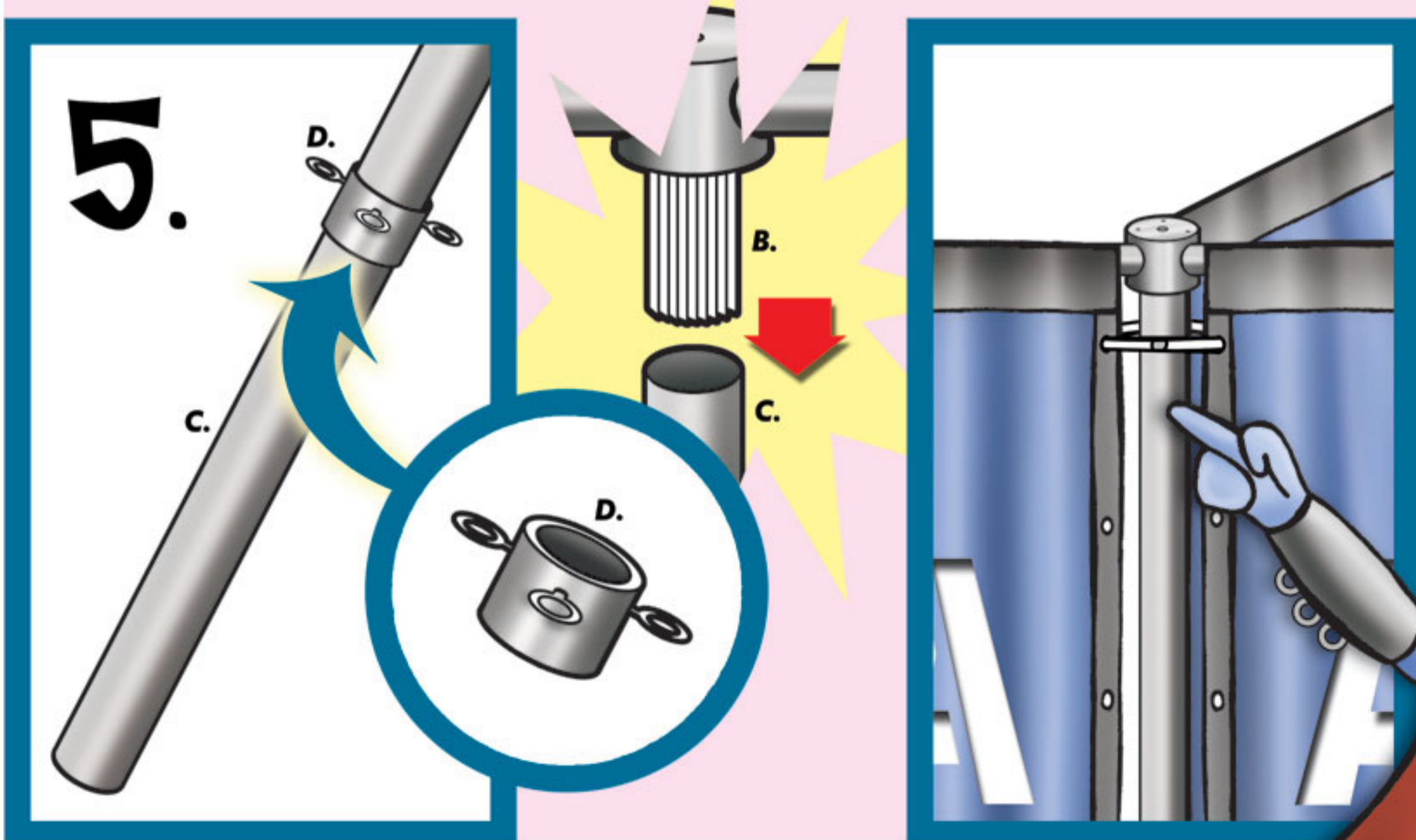

7.

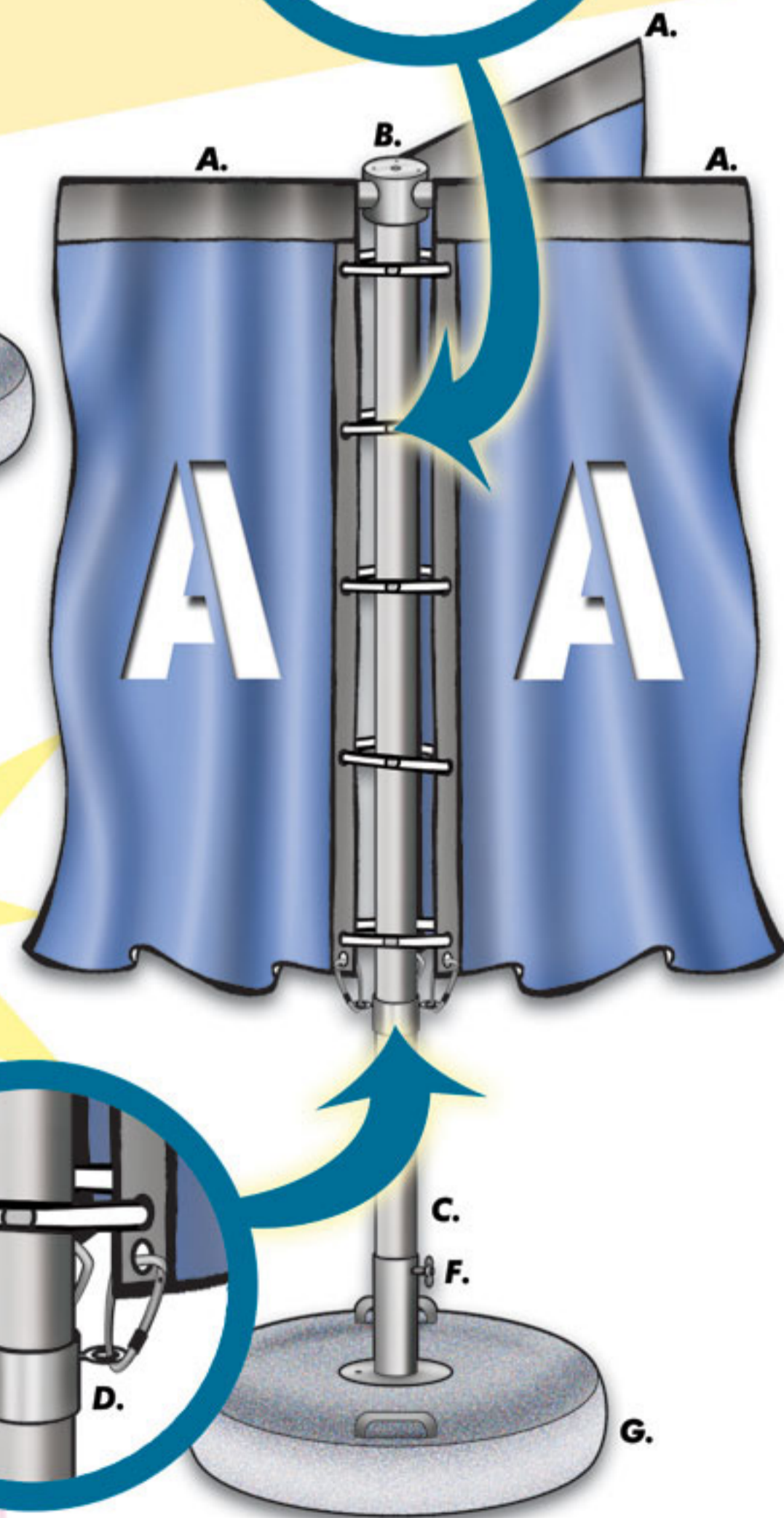

WARNINGS

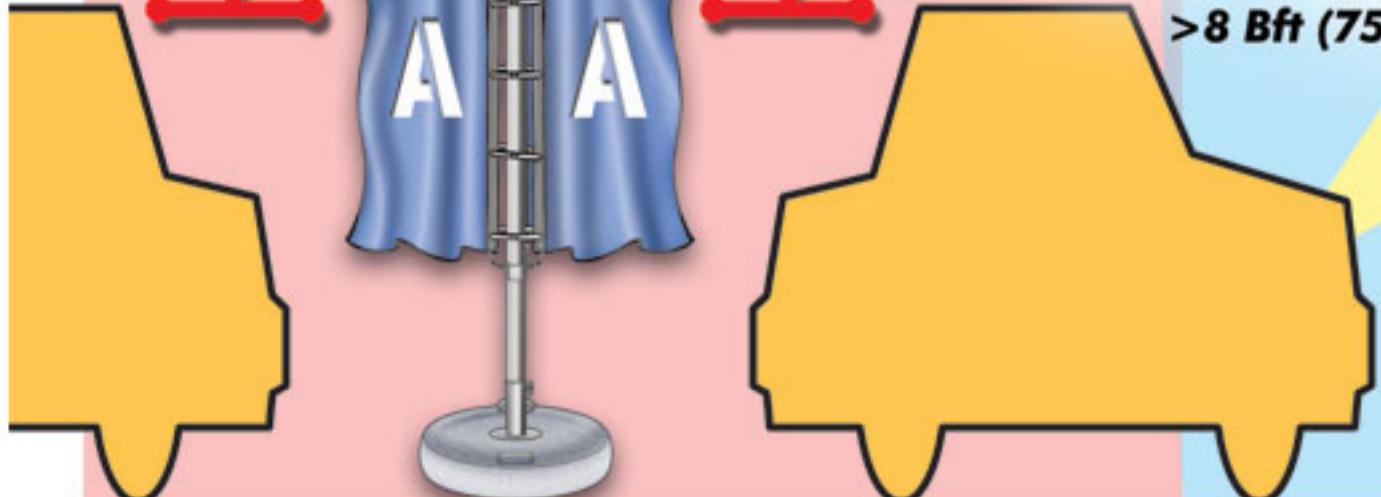
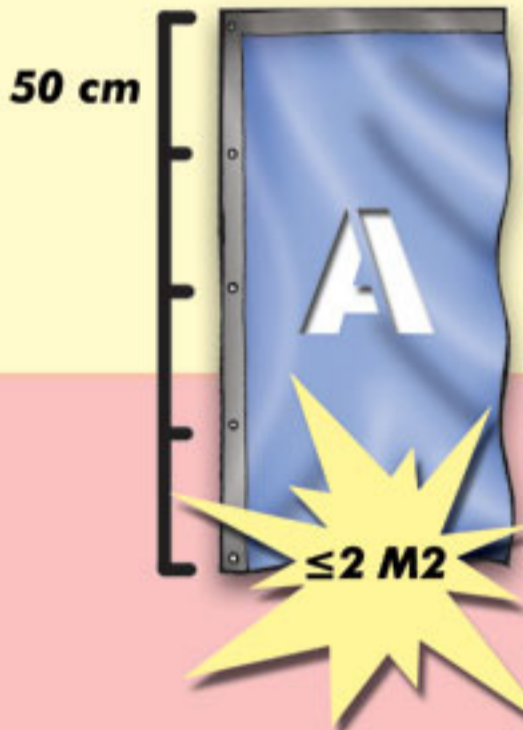
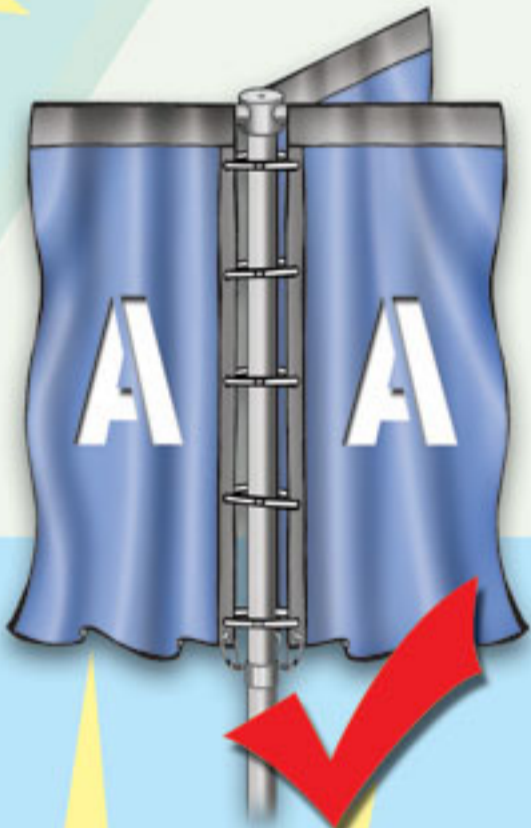
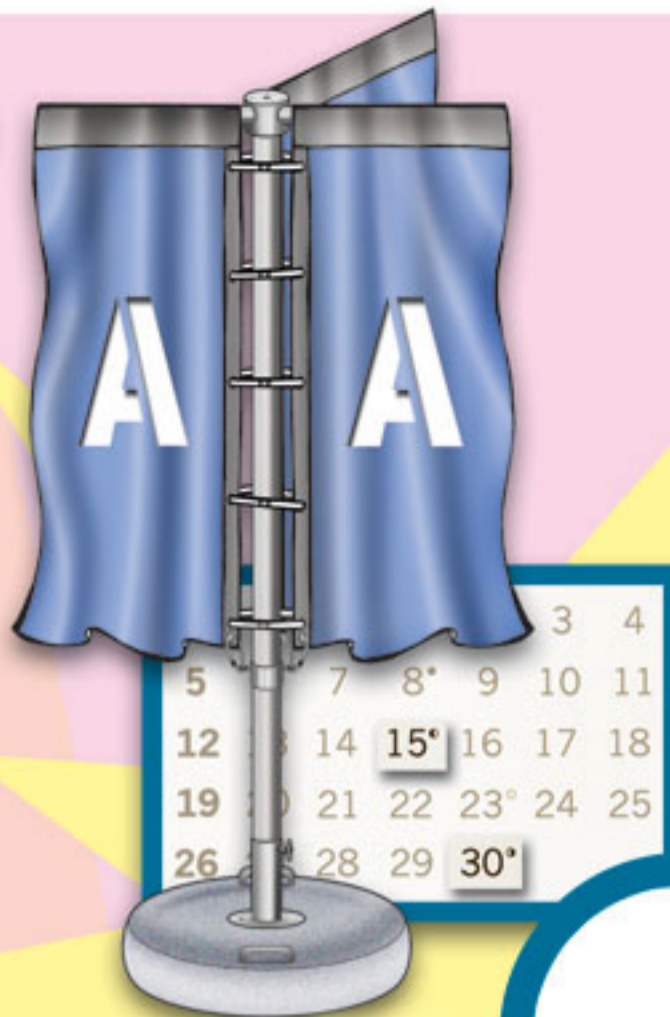
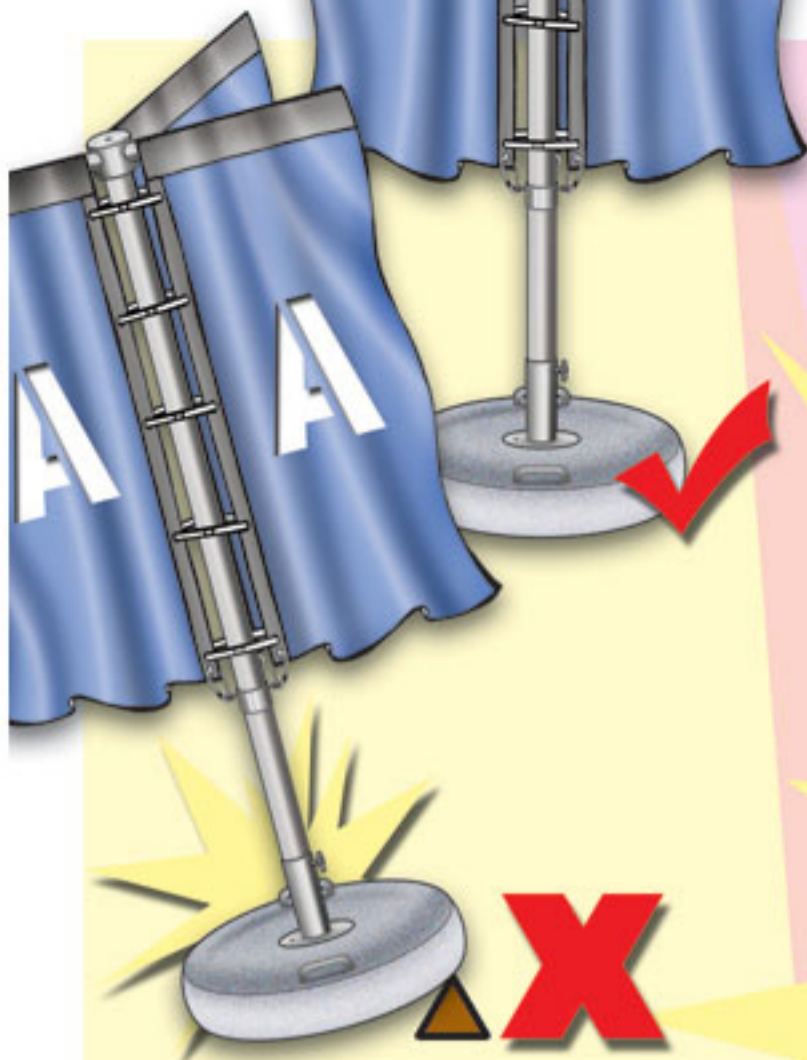

> 8 Bft (75 Km/h, 47 mph)

